

SIGN CAPS, CROSSPIECES & RELATED PRODUCTS

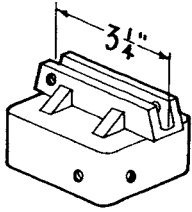

5/16" Set Screw — 6 Places

#850 Short
Available both Flat or
Extruded Blades
Cap for 1 1/2" Square
Tube (Flat Only)
Cap for 1 3/4" Square
Tube
Cap for 2" Square Tube
90 Crosspiece
Slot 3 1/4" Long

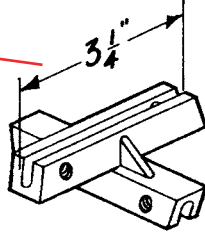

5/16" Set Screw — 4 Places

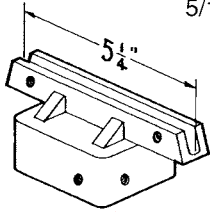

5/16" Set Screw — 6 Places

#850 Long
Available for both Flat
and Extruded Blades
Cap for 1 3/4" Square
Tube
Cap for 2" Square Tube
Cap for 2 1/2" Square
Tube

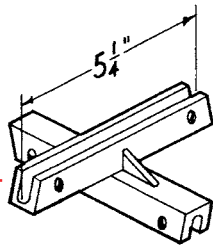

5/16" Set Screw — 4 Places

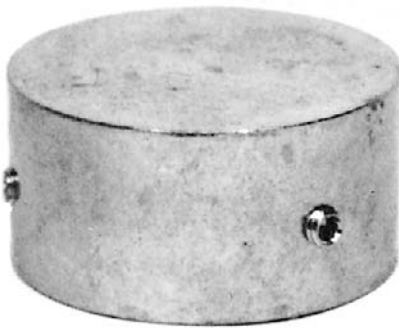

ROUND CLOSURE CAP



SQUARE CLOSURE CAP

#812
Flat or Extruded
Cap &
Crosspiece for 2"
Pipe, 2" Square,
U-Channel

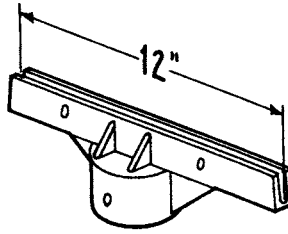

5/16" Set Screw — 5 Places

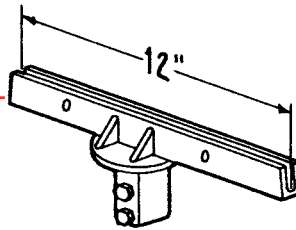

5/16" Set Screw — 2 Places
5/16" x 3/4" Bolt — 2 Places

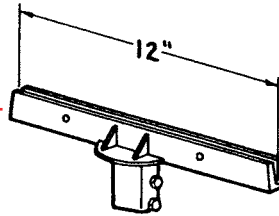

5/16" Set Screw — 2 Places
5/16" x 3/4" Bolt — 2 Places

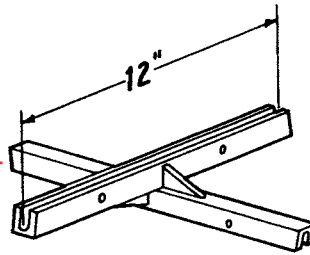

5/16" Set Screw — 4 Places

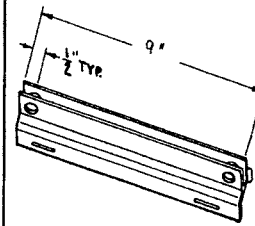

#730 Cantilever
Bracket for Extruded
Blades
For 6" Blades
For 6 3/4" Blades
For 9" Blades
Hex Cap Bolt & Nut

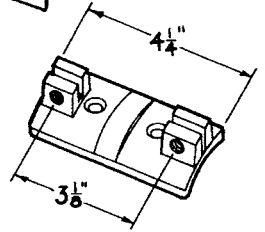

5/16" Set Screw — 2 Places

#721 Wing
Bracket for
Flat blade
Only

#827
Available for
both Flat and
Extruded Blades
4"x4" Wood Post

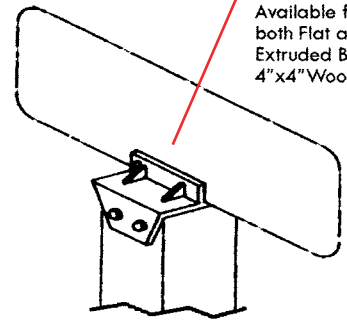

#702 Ring
Bracket for 2"
Round Pipe
(2 3/8" o.d.)

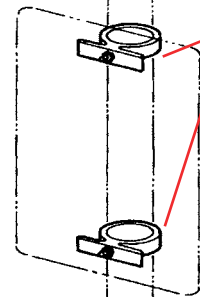

#318 Ring Brackets
Single for 2" Pipe
Only
Double for 2" Pipe
Only
(2 3/8" o.d.)

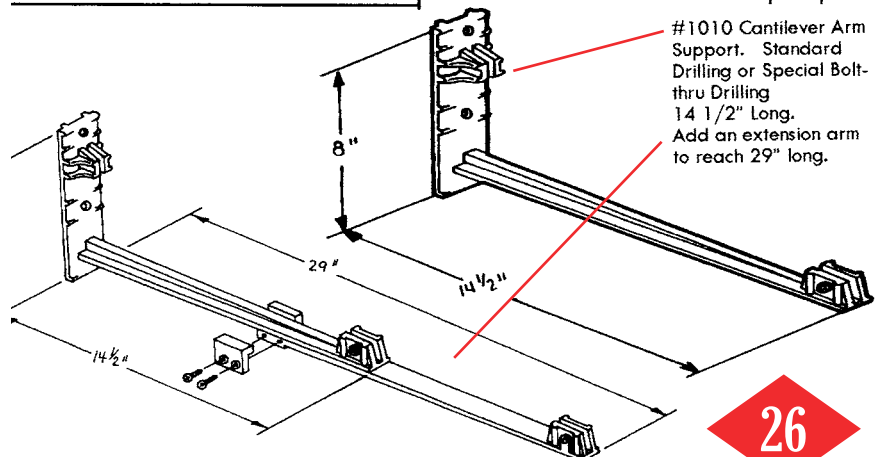
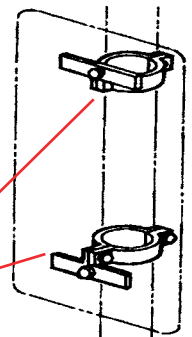

#1010 Cantilever Arm
Support. Standard
Drilling or Special Bolt-
thru Drilling
14 1/2" Long.
Add an extension arm
to reach 29" long.